

# **L2/L4 Managed Gigabit Ethernet Switch**

## **GS-4210 802.3bt PoE++ Series**

### **Quick Installation Guide**

## Table of Contents

|  |    |
|--|----|
| 1. Package Contents .....                        | 3  |
| 2. Requirements .....                            | 5  |
| 3. Terminal Setup .....                          | 6  |
| 3.1 Logging on to the Console .....              | 7  |
| 3.2 Configuring IP Address via the Console.....  | 9  |
| 3.3 Storing Current Switch Configuration .....   | 10 |
| 4. Starting Web Management .....                 | 11 |
| 4.1 Logging in to the Managed Switch.....        | 11 |
| 4.2 Saving Configuration via the Web.....        | 15 |
| 5. Recovering Back to Default Configuration..... | 16 |
| 6. Customer Support .....                        | 18 |

## 1. Package Contents

Thank you for purchasing PLANET L2/L4 Managed Gigabit Ethernet Switch. The descriptions of this series are shown below:

| Model            | Description  |
|------------------|--|
| GS-4210-8UP2S    | 8-Port 10/100/1000T 802.3bt PoE + 2-Port 100/1000X SFP Managed Ethernet Switch                   |
| GS-4210-16UP4C   | 16-port 10/100/1000T 802.3bt PoE + 4-port Gigabit TP/SFP Combo Managed Switch                    |
| GS-4210-24UP4C   | 24-port 10/100/1000T 802.3bt PoE + 4-port Gigabit TP/SFP Combo Managed Switch                    |
| GS-4210-16UP8T4X | 16-Port 10/100/1000T 802.3bt PoE + 8-Port 10/100/1000T + 4-Port 10G SFP+ Managed Ethernet Switch |
| GS-4210-24UP4X   | 24-Port 10/100/1000T 802.3bt PoE + 4-Port 10G SFP+ Managed Ethernet Switch                       |

**“Managed Switch”** mentioned in this Quick Installation Guide refers to the above models.

Open the box of the Managed Switch and carefully unpack it. The box should contain the following items:

| Model Name<br>Packaged Item                       | GS-4210-8UP2S | GS-4210-16UP4C | GS-4210-24UP4C | GS-4210-16UP8T4X | GS-4210-24UP4X |
|---|---------------|----------------|----------------|------------------|----------------|
| The Managed Switch                                | ■             | ■              | ■              | ■                | ■              |
| QR Code Sheet                                     | ■             | ■              | ■              | ■                | ■              |
| CloudViewerPro Quick Guide                        | ■             | ■              | ■              | ■                | ■              |
| RS-232 to RJ45 Console Cable                      | ■             | ■              | ■              | ■                | ■              |
| Rubber Feet                                       | ■             | ■              | ■              | ■                | ■              |
| Two Rack-mounting Brackets with Attachment Screws | ■             | ■              | ■              | ■                | ■              |
| Power Cord  | ■             | ■              | ■              | ■                | ■              |
| SFP Dust Caps                                     | 2             | 4              | 4              | 4                | 4              |

If any item is found missing or damaged, please contact your local reseller for replacement.

## 2. Requirements

- The Managed Switch provides local and remote login interface for management purposes. The following equipment is necessary for further management:
- **Workstations** running Windows 7/8/10/11, macOS 10.12 or later, Linux Kernel 2.6.18 or later, or other modern operating systems are compatible with TCP/IP Protocols.
- Workstations are installed with **Ethernet NIC** (Network Interface Card).
- **Serial Port Connection** (Terminal)
  - The above Workstations come with **COM Port** (DB9) or USB-to-RS-232 converter.
  - The above Workstations have been installed with **terminal emulator**, such as Hyper Terminal included in Windows XP/2003, putty or tera term.
  - **Serial cable** -- One end is attached to the RS-232 serial port, while the other ends to the RJ45 type console port of the Managed Switch.
- **Ethernet Port Connection**
  - **Network cables** -- Use standard network (UTP) cables with RJ45 connectors.
  - The above PC is installed with **Web browser**.



Note

It is recommended to use Google Chrome, Microsoft Edge or Firefox to access the Managed Switch. If the Web interface of the Managed Switch is not accessible, please turn off the anti-virus software or firewall and then try it again.

### 3. Terminal Setup

The Managed Switch is equipped with a console interface for local switch setup and maintenance. To configure the system, connect a serial cable to a **COM port** on a PC or notebook computer and to the RJ45 type of the console port of the Managed Switch.

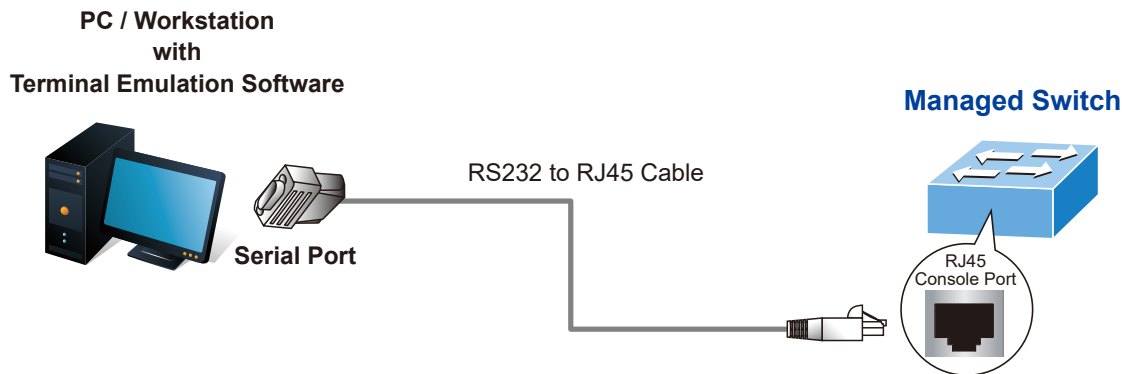

Figure 3-1: Managed Switch Console Connectivity

A terminal program is required to make the software connection to the Managed Switch.

1. Run terminal program on the OS.
2. When the following screen appears, make sure that the COM port should be configured as:
  - ◆ Baud: 115200
  - ◆ Data bits: 8
  - ◆ Parity: None
  - ◆ Stop bits: 1
  - ◆ Flow control: None

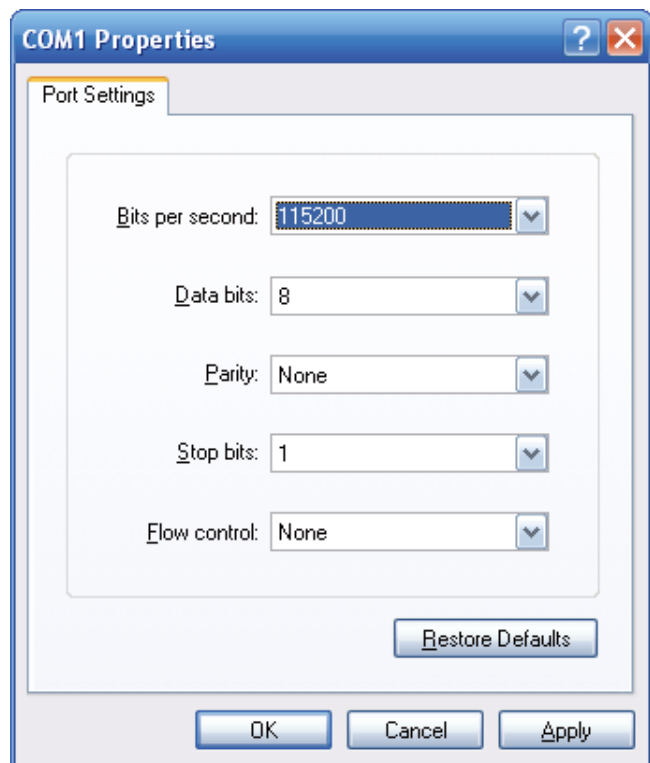

Figure 3-2: COM Port Configuration

### 3.1 Logging on to the Console

Once the terminal is connected to the device, power on the Managed Switch and the terminal will display “**running testing procedures**”. Then, the following message asks to log in user name and password. The factory default user name and password are shown as follows, and the login screen in Figure 3-3 appears.



Note

The following console screen is based on the firmware version before **February of 2024**.

Username: **admin**

Password: **admin**

```
Press any key to continue
Username: admin
Password: *****
GS-4210#
```

**Figure 3-3:** Managed Switch Console Login Screen

The user can now enter commands to manage the Managed Switch. For a detailed description of the commands, please refer to the following chapters.



Note

1. For security reason, please change and memorize the new password after this first setup.
2. Only accept command in lowercase letter under console interface.



Note

The following console screen is based on the firmware version of **February of 2024 or after**.

Username: **admin**

Password: **sw + the last 6 characters of the MAC ID in lowercase**

Find the MAC ID on your device label. The default password is "sw" or "mc" followed by the last six lowercase characters of the MAC ID.

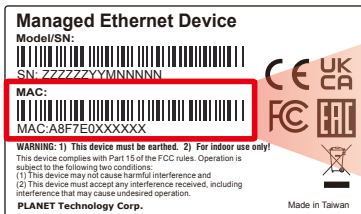

MAC ID: A8F7E0XXXXXX  
Default Password: swXXXXXX  
("x" means the last 6 digits of the MAC address.  
All characters should be in lowercase.)

Figure 3-4: Managed Switch MAC ID Label

Enter the default username and password, then set a new password according to the rule-based prompt and confirm it. Upon success, press any key to return to the login prompt. Log in with "admin" and the "new password" to access the CLI.

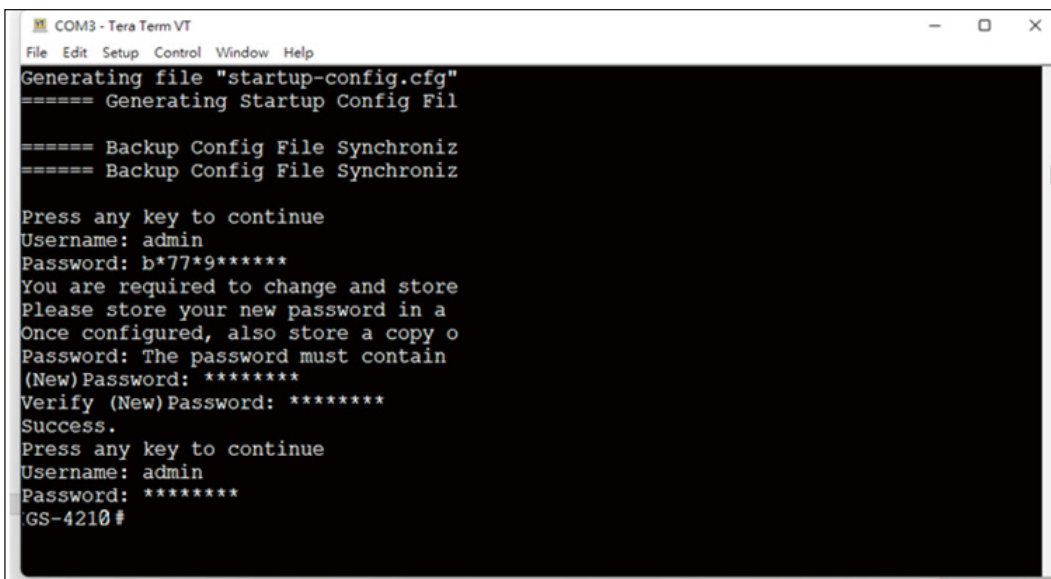

Figure 3-5: Create a New Password and Login Again

The user can now enter commands to manage the Managed Switch. For a detailed description of the commands, please refer to the following chapters.



## 3.2 Configuring IP Address via the Console

The Managed Switch is shipped with default IP address as follows:

```
IP Address: 192.168.0.100  
Subnet Mask: 255.255.255.0
```

To check the current IP address or modify a new IP address for the Switch, please use the procedures as follows:

### ■ Showing the current IP address

1. At the "**GS-4210 Series#**" prompt, enter "**show ip**".
2. The screen displays the current IP Address, Subnet Mask and Gateway as shown in Figure 3-6.

```
Press any key to continue  
Username: admin  
Password: *****  
GS-4210# show ip  
IP Address: 192.168.0.100  
Subnet Netmask: 255.255.255.0  
Default Gateway: 192.168.0.254
```

Figure 3-6: IP Information Screen

### ■ Configuring IP address

3. At the "**GS-4210 Series#**" prompt, enter "**configure**".
4. At the "**GS-4210 Series(config)#**" prompt, enter the following command and press **<Enter>** as shown in Figure 3-7.

```
GS-4210 Series(config)# ip address 192.168.1.100 mask 255.255.255.0  
GS-4210 Series(config)# ip default-gateway 192.168.1.254
```

The previous command would apply the following settings for the Switch.

```
IP Address: 192.168.1.100  
Subnet Mask: 255.255.255.0  
Gateway: 192.168.1.254
```

```
Press any key to continue  
Username: admin  
Password: *****  
GS-4210# configure  
GS-4210(config)# ip address 192.168.1.100 mask 255.255.255.0  
GS-4210(config)# ip default-gateway 192.168.1.254
```

Figure 3-7: IP Address Screen

5. Repeat Step 1 to check if the IP address has changed.

If the IP is successfully configured, the Managed Switch will apply the new IP address setting immediately. You can access the Web interface of the GS-4210 Managed Switch Series through the new IP address.

### 3.3 Storing Current Switch Configuration

In the Managed switch, the running configuration file is stored in the RAM. In the current version, the running configuration sequence of running-config can be saved from the RAM to FLASH by **writing** the command or **copying** the **running-config startup-config** command, so that the running configuration sequence becomes the startup configuration file, which is the configuration saved.

1. At the "GS-4210 Series#" prompt, enter "copy running-config startup-config" as shown in Figure 3-8.

```
Press any key to continue
Username: admin
Password: *****
GS-4210# copy running-config startup-config
Success
```

Figure 3-8: Storing Current Configuration Command Screen



Note

If you are not familiar with console command or the related parameter, enter "?" anytime in console to get the help description.

## 4. Starting Web Management

The following shows how to start up the **Web Management** of the Managed Switch. Note the Managed Switch is configured through an Ethernet connection. Please make sure the manager PC must be set to the same **IP subnet address**.

For example, the default IP address of the Managed Switch is **192.168.0.100**, then the manager PC should be set to **192.168.0.x** (where x is a number between 1 and 254, except 100), and the default subnet mask is 255.255.255.0.

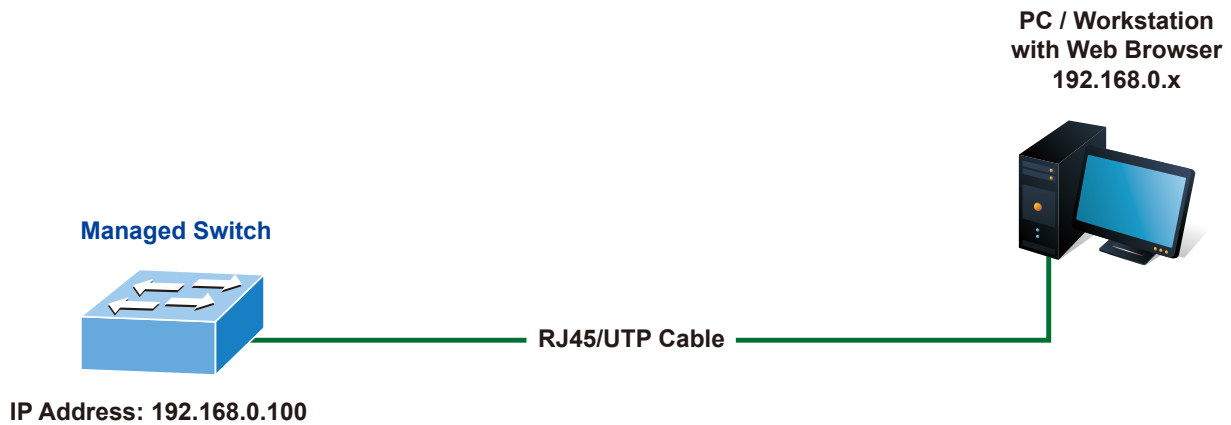

Figure 4-1: IP Management Diagram

### 4.1 Logging in to the Managed Switch

1. Use Chrome 98.0.xxx or above Web browser and enter IP address **<https://192.168.0.100>** to access the Web interface.



Note

The following web screen is based on the firmware version before **February of 2024**.

- When the following dialog box appears, please enter the default user name and password **"admin"**. The login screen in Figure 4-2 appears.

Default IP address: **192.168.0.100**  
Default Username: **admin**  
Default Password: **admin**



**Figure 4-2:** Login Screen

- After entering the password, the main screen appears as Figure 4-6 shows.



Note

The following web screen is based on the firmware version of **February of 2024 or after**.

- When the following dialog box appears, please enter the default user name **"admin"** and password. Refer to **Section 3.1** to determine your initial login password.

Default IP Address: **192.168.0.100**  
Default User Name: **admin**  
Default Password: **sw + the last 6 characters of the MAC ID in lowercase**

5. Find the MAC ID on your device label. The default password is "sw" or "mc" followed by the last six lowercase characters of the MAC ID.

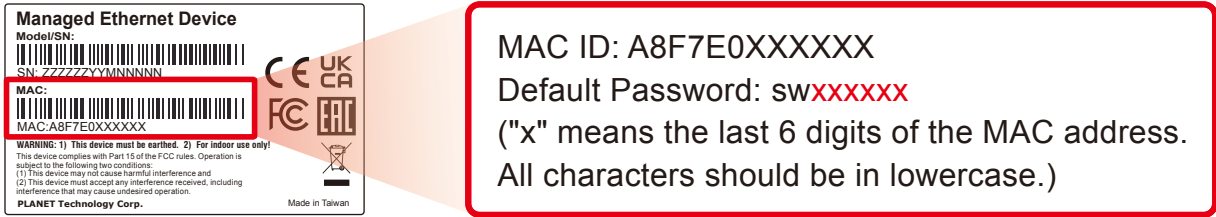

Figure 4-3: Industrial Managed Switch MAC ID Label



Figure 4-4: Login Screen

6. After logging in, you will be prompted to change the initial password to a permanent one.

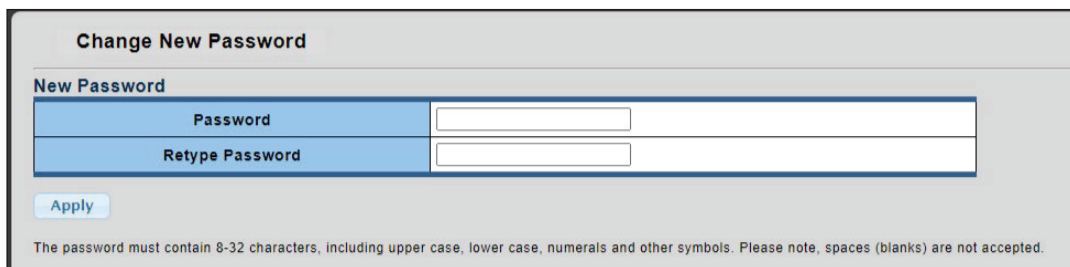

Figure 4-5: Create a New Password

7. Enter the default username and password, then set a new password according to the rule-based prompt and confirm it. Upon success, press any key to return to the login prompt. Log in with "admin" and the "new password" to access the Web interface.



**Figure 4-6:** Web Main Screen of Managed Switch

The Switch Menu on the top of the Web page lets you access all the commands and statistics the Managed Switch provides. The Switch Menu always contains one or more buttons, such as **"System"**, **"Switching"**, **"QoS"**, **"Security"**, **"Ring"**, **"PoE"** and **"Maintenance"**.



**Figure 4-7:** Switch Menu

Now, you can use the Web management interface to continue the Switch management. Please refer to the user's manual for more.

## 4.2 Saving Configuration via the Web

To save all applied changes and set the current configuration as a startup configuration, the startup-configuration file will be loaded automatically across a system reboot.

1. Click **"Save > Save Configurations to FLASH"** to log in to the "Configuration Manager" page.

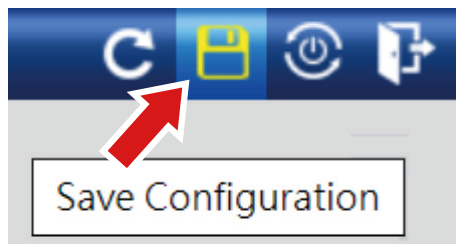

2. Press the **"Apply"** button to save running configuration to start up configuration.

**Configuration Manager**

**Save Configuration**

|                         |   |
|-------------------------|---|
| <b>Source File</b>      | <input checked="" type="radio"/> Running configuration<br><input type="radio"/> Startup configuration<br><input type="radio"/> Backup configuration |
| <b>Destination File</b> | <input checked="" type="radio"/> Startup configuration<br><input type="radio"/> Backup configuration  |

**Apply**

## 5. Recovering Back to Default Configuration

### ■ IP address has been changed or admin password has been forgotten –

To reset the IP address to the default IP Address **"192.168.0.100"** and the user name password to factory default mode (default password is admin or sw + the last 6 characters of the MAC ID in lowercase), press the hardware-based reset button on the front panel for about **10 seconds**. After the device is rebooted, you can log in the management Web interface within the same subnet of 192.168.0.xx.

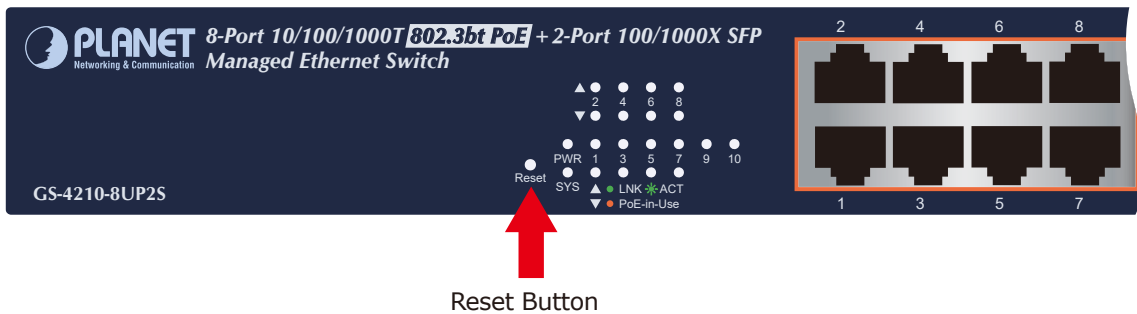

Figure 5-1: GS-4210-8UP2S Reset Button

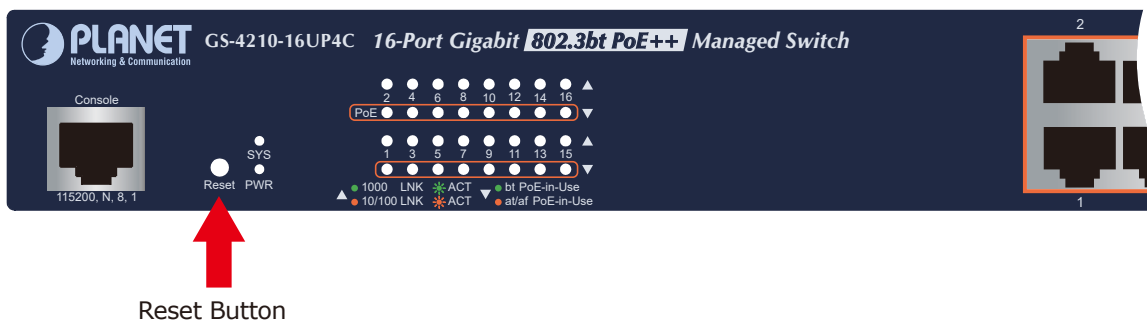

Figure 5-2: GS-4210-16UP4C Reset Button

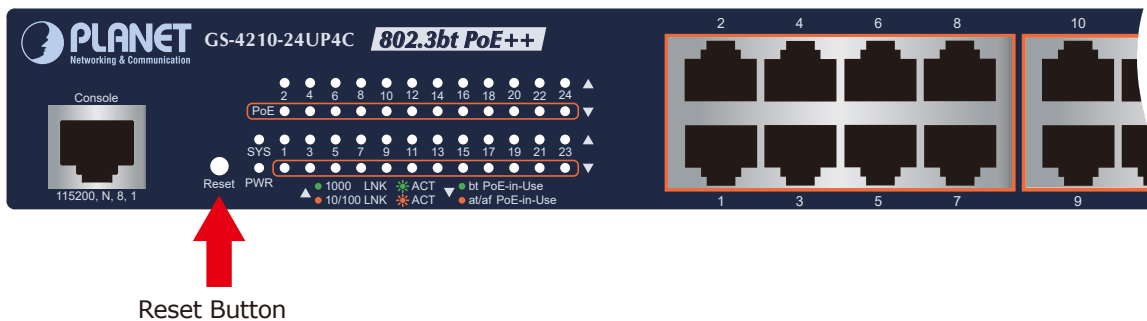
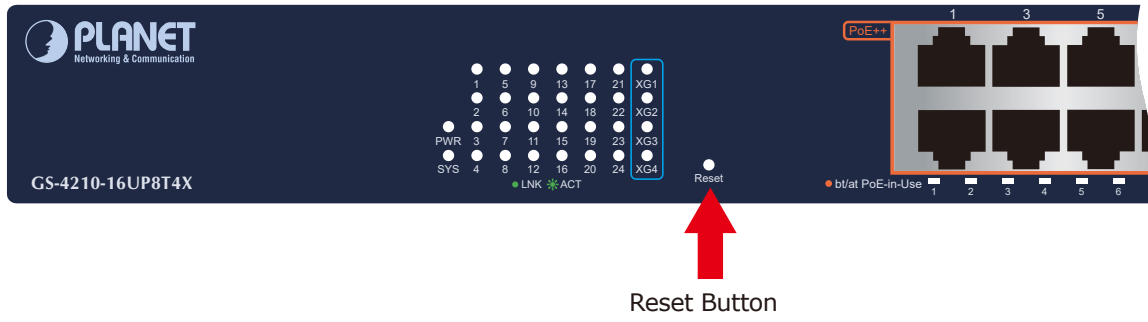

Figure 5-3: GS-4210-24UP4C Reset Button





**Figure 5-4:** GS-4210-24UP4X and GS-4210-16UP8T4X Reset Button

## 6. Customer Support

Thank you for purchasing PLANET products. You can browse our online FAQ resource and User's Manual on PLANET Web site first to check if it could solve your issue. If you need more support information, please contact PLANET support team.

PLANET online FAQs:

<https://www.planet.com.tw/en/support/faq>

Support team mail address:

[support@planet.com.tw](mailto:support@planet.com.tw)

GS-4210 802.3bt PoE Series User's Manual:

<https://www.planet.com.tw/en/support/download.php?&method=keyword&keyword=GS-4210&view=3#list>



(Please select your switch model name from Product Model drop-down menu)

Copyright © PLANET Technology Corp. 2024.

Contents are subject to revision without prior notice.

PLANET is a registered trademark of PLANET Technology Corp.

All other trademarks belong to their respective owners.